

Go to
businessphones.vtech.com
to register your product for
enhanced warranty support
and latest VTech product
news.

UP407

ErisBusinessSystem™

4-Line Office Phones
Cordless Handset



vtech®

Abridged user's manual

Congratulations

on your purchase of this VTech product. Before using this product, please read the **Important safety information**.

This abridged user's manual provides you with the basic installation and setup instructions. You may refer to the online complete user's manual for complete installation and operation instructions at **businessphones.vtech.com**.

For customer service or product information, visit our website at **businessphones.vtech.com** or call **1 (800) 595-9511**. In Canada, please dial **1 (800) 267-7377**.

Model number: ErisBusinessSystem™ UP407

Type: 4-Line Office Phones Cordless Handset

Serial number: _____

Purchase date: _____

Place of purchase: _____

Both the model and serial numbers of your VTech product can be found on the bottom of the telephone base.

Save your sales receipt and original packaging in case it is necessary to return your telephone for warranty service.



Telephones identified with this logo have reduced noise and interference when used with most T-coil equipped hearing aids and cochlear implants. The TIA-1083 Compliant Logo is a trademark of the Telecommunications Industry Association. Used under license.

Important safety information



This symbol is to alert you to important operating or servicing instructions that may appear in this user's manual. Always follow basic safety precautions when using this product to reduce the risk of injury, fire, or electric shock.

Safety information

- Read and understand all instructions in the user's manual. Observe all markings on the product.
- Avoid using a telephone during a thunderstorm. There may be a slight chance of electric shock from lightning.
- Do not use the telephone to report a gas leak in the vicinity of the leak. Under certain circumstances, a spark may be created when the adapter is plugged into the power outlet, or when the handset is replaced in its cradle. This is a common event associated with the closing of any electrical circuit. The user should not plug the phone into a power outlet, and should not put a charged handset into the cradle, if the phone is located in an environment containing concentrations of flammable or flame-supporting gases, unless there is adequate ventilation. A spark in such an environment could create a fire or explosion. Such environments might include: medical use of oxygen without adequate ventilation; industrial gases (cleaning solvents; gasoline vapors; etc.); a leak of natural gas; etc.
- Do not use this product near water, or when you are wet. For example, do not use it in a wet basement or shower, or next to a swimming pool, bathtub, kitchen sink, or laundry tub. Do not use liquids or aerosol sprays for cleaning. If the product comes in contact with any liquid, unplug any line or power cord immediately. Do not plug the product back in until it has dried thoroughly.
- Install this product in a protected location where no one can trip over any line or power cords. Protect cords from damage or abrasion.
- If this product does not operate normally, see the **Troubleshooting** section of the online complete user's manual. If you cannot solve the problem, or if the product is damaged, refer to the **Limited warranty** section on pages 37-39. Do not open this product except as directed in the user's manual. Opening the product or reassembling it incorrectly may expose you to hazardous voltages or other risks.
- Replace backup battery only as described in the user's manual. Do not burn or puncture batteries — they contain caustic chemicals.
- This power adapter is intended to be correctly oriented in a vertical or floor mount position. The prongs are not designed to hold the plug in place if it is plugged into a ceiling, an under-the-table or cabinet outlet.



Caution:

- Use only the power adapter and rechargeable battery provided with this product. To obtain a replacement, visit our website at **businessphones.vtech.com** or call **1 (800) 595-9511**. In Canada, dial **1 (800) 267-7377**.
- N'utilisez que le bloc-piles inclus avec cet appareil ou l'équivalent. Pour commander un bloc-piles, composez le **1 (800) 267-7377** ou visitez notre site Web au **businessphones.vtech.com**.

Important safety information

Especially about cordless telephones

- **Privacy:** The same features that make a cordless telephone convenient create some limitations. Telephone calls are transmitted between the telephone base and the handset by radio waves, so there is a possibility that your cordless telephone conversations could be intercepted by radio receiving equipment within range of the cordless handset. For this reason, you should not think of cordless telephone conversations as being as private as those on corded telephones.
- **Electrical power:** The telephone base of this cordless telephone must be connected to a working electrical outlet which is not controlled by a wall switch. Calls cannot be made from the handset if the telephone base is unplugged, switched off or if the electrical power is interrupted.
- **Potential TV interference:** Some cordless telephones operate at frequencies that may cause interference to TVs and VCRs. To minimize or prevent such interference, do not place the telephone base of the cordless telephone near or on top of a TV or VCR. If interference is experienced, moving the cordless telephone farther away from the TV or VCR will often reduce or eliminate the interference.
- **Rechargeable batteries:** This product contains nickel-metal hydride rechargeable batteries. Exercise care in handling batteries in order not to create a short circuit with conductive material such as rings, bracelets, and keys. The battery or conductor may overheat and cause harm. Observe proper polarity between the battery and the battery charger.
- **Nickel-metal hydride rechargeable batteries:** Dispose of these batteries in a safe manner. Do not burn or puncture. Like other batteries of this type, if burned or punctured, they could release caustic material which could cause injury.



The RBRC™ Seal means that the manufacturer is voluntarily participating in an industry program to collect and recycle nickel-metal hydride rechargeable batteries when taken out of service within the United States. These batteries may be taken to a participating local retailer of replacement batteries or recycling center. You may call 1 (800) 8-BATTERY for locations accepting spent Ni-MH batteries.

Important safety information

Precautions for users of implanted cardiac pacemakers

Cardiac pacemakers (applies only to digital cordless telephones):

Wireless Technology Research, LLC (WTR), an independent research entity, led a multidisciplinary evaluation of the interference between portable wireless telephones and implanted cardiac pacemakers. Supported by the U.S. Food and Drug Administration, WTR recommends to physicians that:

Pacemaker patients

- Should keep wireless telephones at least six inches from the pacemaker.
- Should NOT place wireless telephones directly over the pacemaker, such as in a breast pocket, when it is turned ON.
- Should use the wireless telephone at the ear opposite the pacemaker.

WTR's evaluation did not identify any risk to bystanders with pacemakers from other persons using wireless telephones.

Especially about telephone answering systems

Two-way recording: This unit does not sound warning beeps to inform the other party that the call is being recorded. To ensure that you are in compliance with any federal or state regulations regarding recording a telephone call, you should start the recording process and then inform the other party that you are recording the conversation.

SAVE THESE INSTRUCTIONS

Parts checklist

Your telephone package contains the following items. Save your sales receipt and original packaging in the event warranty service is necessary.



Abridged user's manual



Cordless handset



Battery compartment cover



Battery for cordless handset



Charger for cordless handset with power adapter installed

Table of contents

Getting started

Handset overview	1
Handset screen icons	4
Alert tones and lights.....	5
Alert tones	5
Indicator lights	5
Charger installation.....	6
Battery installation and charging	7
Wall mount installation.....	9
Adding and registering a handset	11
Deregistering a handset	14

Telephone settings

Telephone setup	16
Ringer volume	16
Ringer tone.....	17
LCD Language	18
Key tone	19
LCD contrast	19

Telephone operation

Telephone operation	20
Making and ending a call.....	20
On hook dialing (predialing) ...	20
Using the speakerphone	20
Answering a call	21
Temporary ringer silencing	21

Redial	21
Options while on calls.....	22
Call waiting	22
Volume control.....	22
Mute	22
Conference call.....	23
A. Inviting parties using Intercom	24
B. Join a call in progress	24
Intercom.....	25
Make an intercom call to an extension.....	25
Answer an intercom call	25
End an intercom call.....	25
Answer an incoming call during an intercom call.....	25

Directory

Create directory entries	26
Create a new directory entry	26
Review directory entries	26
Search directory	27
Search by name	27

Caller ID

Caller ID operation.....	28
Review the caller ID information	28
Dial a call history entry	28

Table of contents

Answering system

Private mailbox setup	29
Announcement	29
Answering system operation	30
Visual message waiting indicator.....	30
Message playback.....	30

Appendix

Troubleshooting	31
Maintenance	33
FCC Part 68 and ACTA	34
FCC Part 15.....	36
Limited warranty	37
Technical specifications	40

Getting started

Handset overview

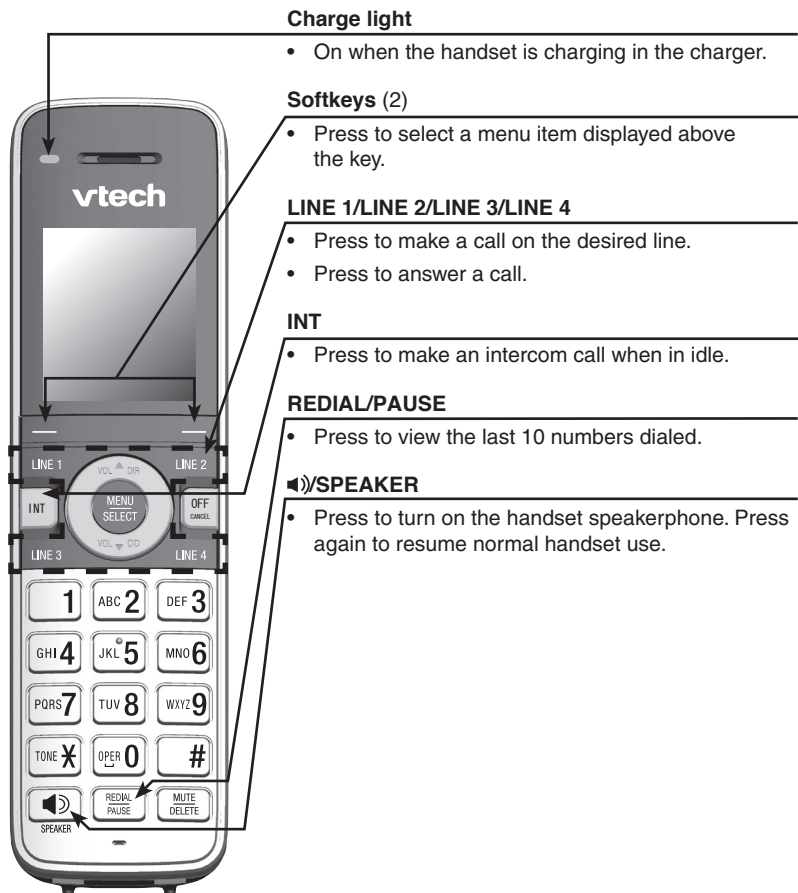

Charge light

- On when the handset is charging in the charger.

Softkeys (2)

- Press to select a menu item displayed above the key.

LINE 1/LINE 2/LINE 3/LINE 4

- Press to make a call on the desired line.
- Press to answer a call.

INT

- Press to make an intercom call when in idle.

REDIAL/PAUSE

- Press to view the last 10 numbers dialed.

)/SPEAKER

- Press to turn on the handset speakerphone. Press again to resume normal handset use.

Getting started

Handset overview



VOL/▲DIR

- Press to scroll up while in menus.
- During a call, press to increase the listening volume.
- Press to show directory entries when the telephone is not in use.

MENU/SELECT

- Press to enter the menu.
- While in a menu, press to select an item or save an entry or setting.

OFF/CANCEL

- While using menus, press to return to idle mode.
- During a call, press to hang up.

VOL/▼CID

- Press to scroll down while in menus.
- During a call, press to decrease the listening volume.
- Press to show the caller ID history when the telephone is not in use.

MUTE/DELETE

- During a call, press to mute the microphone.
- While predialing, press to delete digits.
- While reviewing the directory entry, press to delete an individual entry.
- While entering or editing a directory entry, press to erase a digit or character.

Getting started

Handset overview



Belt clip

Main menu



Main menu





- Ringers
- Phone Settings

Using menus

- Press **MENU/SELECT** or **MENU** to show the first menu item, **Ringers**.
- Press **▲** or **▼** to scroll through menu items.
- Press **MENU/SELECT** or **SELECT** to select or save changes to a highlighted menu item.
- Press **OFF/CANCEL** or **BACK** to cancel an operation, exit the menu display or return to the idle screen.

Getting started

Handset screen icons

L1 L2 L3 L4	Telephone lines - On steadily when line 1, line 2, line 3, or line 4 is in use on this handset, or flashes when there is an incoming call.
	Ringer off - On steadily when the ringer volume is set to OFF .
	Headset - On steadily when using a corded headset.
	Speakerphone - On steadily when using the speakerphone.
MUTE	Mute - Microphone is muted.
	New caller ID log - Missed and new calls.

Getting started

Alert tones and lights

Alert tones

One beep

There is an incoming call waiting.

Five beeps

The telephone has completed the command successfully.

Indicator lights



Charge light

- On when the handset is charging in the charger.

Large Lighted Display

LINE 1/LINE 2/LINE 3/LINE 4

- On when the telephone line is in use.
- Flashes when there is an incoming call.

Backlight (lighted display and dial pad)

- On when the handset is lifted from the charger.
- On when a key is pressed.

SPEAKER light

- On when the speakerphone is in use.

Getting started

Charger installation



The power adapter is intended to be correctly oriented in a vertical or floor mount position. The prongs are not designed to hold the plug in place if it is plugged into a ceiling, under-the-table or cabinet outlet.

Install the charger as shown below.

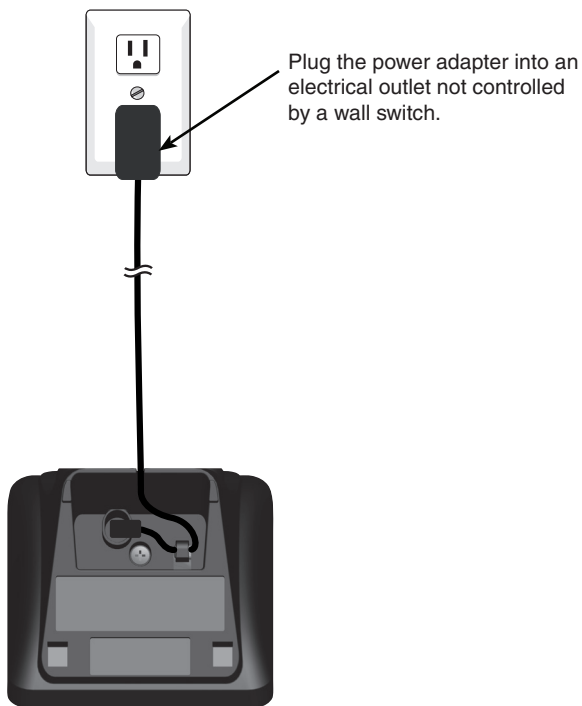



NOTE: Use only the power adapter supplied with this product. To order a replacement power adapter, visit our website at businessphones.vtech.com, or call 1 (800) 595-9511. In Canada, dial 1 (800) 267-7377.

Getting started

Battery installation and charging

Install the battery as shown on the next page. Once you have installed the battery, the screen indicates the battery status (see the table below). If necessary, place the handset in the charger to charge the battery. For best performance, keep the handset in the charger when not in use. The battery is fully charged after 11 hours of continuous charging. See the table on the **Technical specification** on page 40 for battery operating times.

If the screen is blank, you need to charge the handset without interruption for at least 30 minutes to give the handset enough charge to use the telephone for a short time. When the battery is low, the handset shows **Low battery** and a flashing .

Battery indicators	Battery status	Action
The screen is blank or shows Place in charger and  flashes.	The battery has no or very little charge. The handset cannot be used.	Charge without interruption (at least 30 minutes).
The screen shows Low battery and  flashes.	Battery has enough charge to be used for a short time.	Charge without interruption (at least 30 minutes).
The screen shows EXT XX . (XX represents the extension number of its registered device).	Battery is charged.	To keep the battery charged, place the handset in the charger when not in use.

Getting started

Battery installation and charging

Install the battery as shown below.

1. Plug the battery connector securely into the socket inside the handset battery compartment. Insert the supplied battery with the label **THIS SIDE UP** facing up as indicated.
2. Align the cover flat against the battery compartment, then slide it upwards until it clicks into place.
3. Charge the handset by placing it face forward in the charger. The charge light is on when charging.



NOTES:

- Use only the supplied rechargeable battery or replacement battery (model BT166342). To order a replacement battery, visit our website at businessphones.vtech.com, or call 1 (800) 595-9511. In Canada, dial 1 (800) 267-7377.
- N'utilisez que le bloc-piles inclus avec cet appareil ou l'équivalent (modèle BT166342). Pour commander un bloc-piles, composez le 1 (800) 267-7377 ou visitez notre site Web au businessphones.vtech.com.
- If you do not use the handset for a long time, disconnect and remove the battery to prevent possible leakage.

Getting started

Wall mount installation

The charger is ready for tabletop use. If you want to mount the charger on a wall, use two 10mm screws and wall anchors (not provided) to hold the charger in place. The screws and wall anchors are available for purchase in many hardware or consumer electronics retailers. You might need a professional to install the charger.

To mount the charger on the wall

1. Use a pencil to mark the desired positions of the two holes on the wall, make sure the space between the two holes is 30mm. Drill two holes in the wall according to the marks.

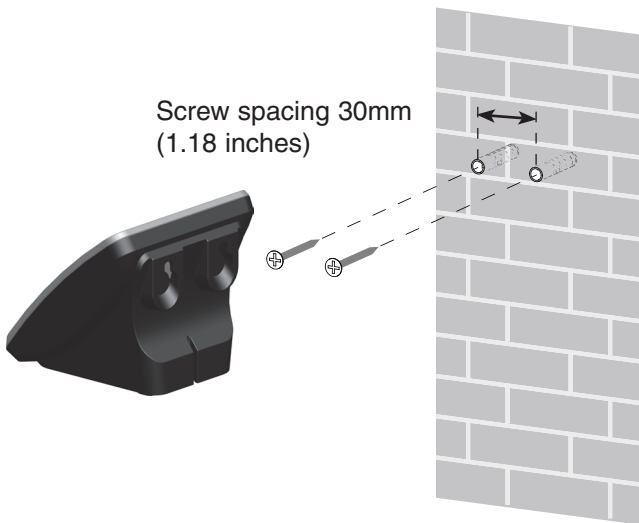

2. If you drill the holes into a stud, go to step 3.

-OR-

If you drill the holes into an object other than a stud, insert the wall anchors (not provided) into the holes and tap gently on the ends with a hammer until the wall anchors are flush with the wall.

Getting started

Wall mount installation

3. Insert the screws (not provided) into the holes and tighten them until only 1/4 inch of the screws are exposed.

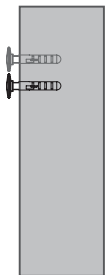

4. Align the holes at the back of the charger with the screws on the wall and slide the charger down until it locks into place.

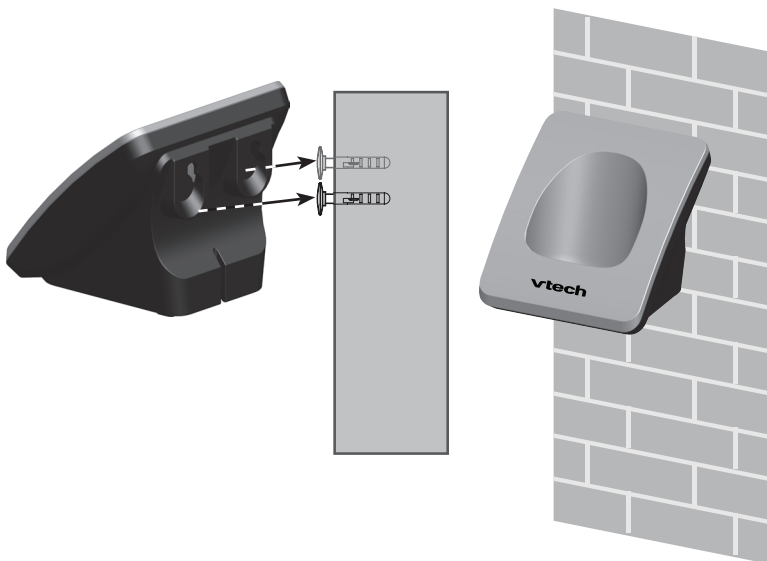

Getting started

Adding and registering a handset

You must register this UP407 cordless handset with the UP416 console or UP406 deskset before use. Each UP416 or UP406 supports only one cordless handset. When first purchased, the handset shows **Choose Handset in Registration at base menu. Put handset on cradle to register.**

If the handset does not have enough power to proceed with the registration, you need to charge the new handset for at least five minutes (see **Battery installation and charging** on pages 7-8). Start registration when the handset screen shows **Choose Handset in Registration at base menu. Put handset on cradle to register.**

Getting started

Adding and registering a handset

To register a handset to your UP416 console

1. Make sure the cordless handset is out of the charger and the screen shows **Choose Handset in Registration at base menu. Put handset on cradle to register.**
2. On the UP416 console, press **MENU/SELECT**.
3. Press **▲** or **▼** to scroll to **Registration**, then press **MENU/SELECT** or **▶/SKIP**.
4. Press **MENU/SELECT** again or press **▶/SKIP** to select **Handset**. The UP416 console screen shows **Registering handset... (Put handset on cradle to start)**.
5. Place the unregistered handset into the charger. The handset screen displays **Registering... Please wait** during registration. The handset beeps once and begins registering to the UP416 console. It takes up to 60 seconds to complete the registration. When the registration is successful, the UP416 console shows **Handset registered**.



NOTE: If the registration is not successful, the console returns to the previous screen. To reset the handset, remove the handset from the charger. Wait for about two minutes, then try the registration process again.

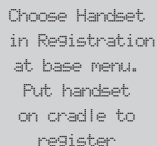

Choose Handset
in Registration
at base menu.
Put handset
on cradle to
register

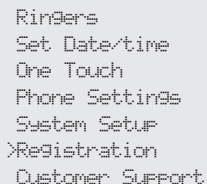

Ringers
Set Date/time
One Touch
Phone Settings
System Setup
>Registration
Customer Support



Registration
>Handset
DECT Headset
Deregistration



Registering
handset...

(Put handset on
cradle to start)

Getting started

Adding and registering a handset

To register a handset to your UP406 deskset

1. Make sure the cordless handset is out of the charger and the screen shows **Choose Handset in Registration at base menu. Put handset on cradle to register.**
2. On the UP406 deskset, press **MENU/SELECT**.
3. Press **▲** or **▼** to scroll to **Registration**, then press **MENU/SELECT** or **▶/SKIP**.
4. Press **MENU/SELECT** again or **▶/SKIP** to select **Handset**. The UP406 deskset screen shows **Registering handset... (Put handset on cradle to start)**.
5. Place the unregistered handset into the charger. The handset screen displays **Registering... Please wait** during registration. The handset beeps once and begins registering to the UP406 deskset. It takes up to 60 seconds to complete the registration. When the registration is successful, the UP406 deskset shows **Handset registered**.



NOTES:

- If the registration is not successful, the deskset returns to the previous screen. To reset the handset, remove the handset from the charger. Wait for about two minutes, then try the registration process again.
- We recommend you avoid using the deskset and the cordless handset at the same time.



Choose Handset
in Registration
at base menu.
Put handset
on cradle to
register

Phone Settings
System Setup
>Registration
Customer Support

Registration
>Handset
DECT Headset
Deregistration

Registering
handset...
(Put handset on
cradle to start)

Getting started

Deregistering a handset

You may need to deregister your cordless handset when you have a registered handset and need to replace one. **Please read all the instructions on this page before beginning the deregistration process.**

Please make sure the telephone system is not in use before deregistration.

To deregister the cordless handset from the UP416 console

1. On the console, press **MENU/SELECT**.
2. Press **▲** or **▼** to scroll to **Registration**, then press **MENU/SELECT** or **▶/SKIP**.
3. Press **▲** or **▼** to scroll to **Deregistration**, then press **MENU/SELECT** or **▶/SKIP**.
4. The screen shows **Deregister all devices? Press 'SELECT' to confirm.** Press **MENU/SELECT** to confirm.
5. The process takes up to 10 seconds to complete. The console shows **Handset deregistered. DECT Headset deregistered.** and there is a confirmation tone when the deregistration is successful.



NOTE: To register a cordless handset to your UP416 console again, refer to the registration information on page 12.

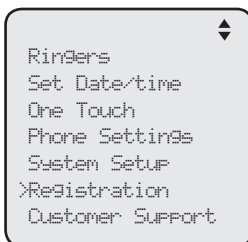

Getting started

Deregistering a handset

To deregister the cordless handset from the UP406 deskset

1. On the deskset, press **MENU/SELECT**.
2. Press **▲** or **▼** to scroll to **Registration**, then press **MENU/SELECT** or **▶/SKIP**.
3. Press **▲** or **▼** to scroll to **Deregistration**, then press **MENU/SELECT** or **▶/SKIP**.
4. The screen shows **Deregister all devices? Press 'SELECT' to confirm.** Press **MENU/SELECT** to confirm.
5. The process up to 10 seconds to complete the deregistration. The deskset shows **Handset deregistered. DECT Headset deregistered.** and there is a confirmation tone when the deregistration is successful.

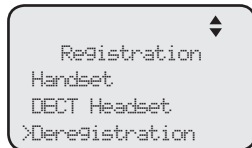
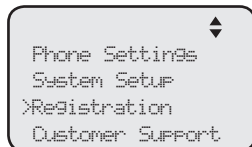

NOTE: To register a cordless handset to your UP406 deskset again, refer to the registration information on page 13.

Telephone settings

Telephone setup

Ringer volume

Use this feature to set the ringer volume to one of six levels or turn the ringer off. When the ringer is off, the  icon appears on the handset screen. The handset stores the volume setting for all lines.

1. When the handset is idle, press **MENU/SELECT** or **MENU**.
2. Press **MENU/SELECT** or **SELECT** to select **Ringers**.
3. Press **MENU/SELECT** or **SELECT** again to select **Ringer volume**.
4. Press **▲DIR** or **▼CID** on the handset to adjust the ringer volume, or press **OFF** to turn the ringer off.
5. Press **MENU/SELECT** or **SET** to save the setting and return to the previous menu. There is a confirmation tone. To exit without making changes, press **OFF/CANCEL**.



NOTE: The ringer volume also determines the ringer volume for intercom calls. If the handset ringer volume is set to off, that handset is silenced for all incoming calls, including intercom calls.

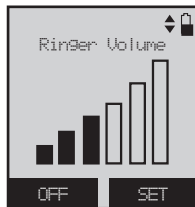
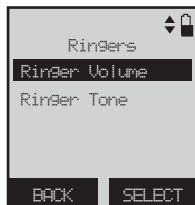
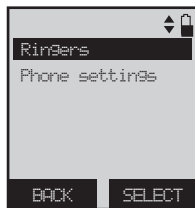

Telephone settings

Telephone setup

Ringer tone

Use this feature to choose one of the ten ringer tones. You can choose different ringer tones for different lines so you can easily identify which line is calling.

1. When the handset is idle, press **MENU/SELECT** or **MENU**.
2. Press **MENU/SELECT** or **SELECT** to select **Ringers**.
3. Press **▲DIR** or **▼CID** to scroll to **Ringer tone**, then press **MENU/SELECT** or **SELECT**.
4. Press **▲DIR** or **▼CID** to select the desired line (**Line 1**, **Line 2**, **Line 3** or **Line 4**), then press **MENU/SELECT** or **SELECT**.
5. Press **▲DIR** or **▼CID** to select a desired ringer tone.
6. Press **MENU/SELECT** or **SELECT** to save the setting and return to the previous menu. There is a confirmation tone. To exit without making changes, press **OFF/CANCEL** or **BACK**.
7. Repeat steps 4-6 above to choose ringer tones for other lines if desired.

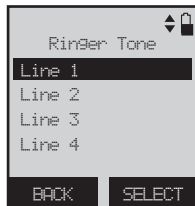
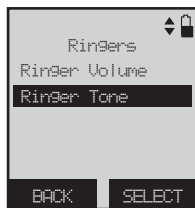

Telephone settings

Telephone setup

LCD Language

This feature allows you to change the language used for handset displays. By default, the language is set to **English**.

1. When the handset is idle, press **MENU/SELECT** or **MENU**.
2. Press **▲DIR** or **▼CID** to scroll to **Phone Settings**, then press **MENU/SELECT** or **SELECT**.
3. Press **MENU/SELECT** or **SELECT** again to select **LCD Language**.
4. Press **▲DIR** or **▼CID** to scroll to **English**, **Français** or **Español**.
5. Press **MENU/SELECT** or **SELECT** to save the setting and return to the previous menu. You hear a confirmation tone. To exit without making changes, press **OFF/CANCEL** or **BACK**.

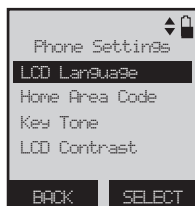
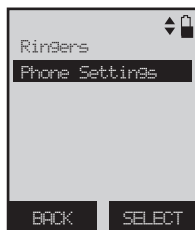

Telephone settings

Telephone setup

Key tone

The handset is set to beep with each key press. If you turn off the key tone, there are no beeps when you press keys.

1. When the handset is idle, press **MENU/SELECT** or **MENU**.
2. Press **▲DIR** or **▼CID** to scroll to **Phone Settings**, then press **MENU/SELECT** or **SELECT**.
3. Press **▲DIR** or **▼CID** to scroll to **Key Tone**, then press **MENU/SELECT** or **SELECT**.
4. Press **▲DIR** or **▼CID** to scroll to **On** or **Off**.
5. Press **MENU/SELECT** or **SELECT** to save the setting and return to the previous menu. You hear a confirmation tone. To exit without making changes, press **OFF/CANCEL** or **BACK**.

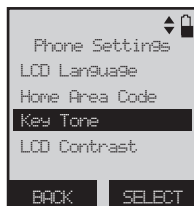

LCD contrast

Use this feature to adjust the screen contrast to one of eight levels to optimize readability in different lighting conditions.

1. When the handset is idle, press **MENU/SELECT** or **MENU**.
2. Press **▲DIR** or **▼CID** to scroll to **Phone Settings**, then press **MENU/SELECT** or **SELECT**.
3. Press **▲DIR** or **▼CID** to scroll to **LCD Contrast**, then press **MENU/SELECT** or **SELECT**.
4. Press **▲DIR** or **▼CID** to scroll to the desired screen contrast level (**Level 1 - Level 8**).
5. Press **MENU/SELECT** or **SELECT** to save the setting. You hear a confirmation tone. To exit without making changes, press **OFF/CANCEL** or **BACK**.

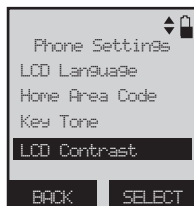

Telephone operation

Telephone operation

Making and ending a call

To make a call:

1. Press the desired line key (**LINE 1-LINE 4**).
2. Wait for a dial tone, then enter the telephone number. The screen displays the elapsed time as you talk (in hours, minutes and seconds).

To end a call:

- Press **OFF/CANCEL** or return the handset to the charger to hang up.
- OR-**
- Press the corresponding line key (**LINE 1-LINE 4**) to hang up.



NOTE: The elapsed time is not affected by accessing services from your telephone service provider.

On hook dialing (predialing)

1. Enter the telephone number. Press **MUTE/DELETE** to make corrections.
2. Press the desired line key **LINE 1-LINE 4** to dial the call.

Using the speakerphone

During a call, press **◀▶/SPEAKER** to switch between handsfree speakerphone and normal handset use. Press **OFF/CANCEL** to hang up.

Telephone operation

Telephone operation

Answering a call

To answer a call:

Press any line key (**LINE 1-LINE 4**).

-OR-

Press **◀/SPEAKER** on the cordless handset to answer using the speakerphone.

Temporary ringer silencing

Press **SILENCE** while the telephone is ringing to silence the ringer temporarily on the handset only. This turns off the ringer without disconnecting the call. The next incoming call rings normally at the preset volume.

Redial

The handset shares the same redial memory with its registered console or deskset. The memory can hold the last 10 telephone numbers dialed (up to 30 digits) from the handset and its registered console or deskset.

To view and dial the 10 most recently dialed numbers:

1. Press **REDIAL/PAUSE** to enter the redial list and display the summary with the total number of redial numbers.
2. Press **REVIEW**, then press **▲DIR** or **▼CID** to view the last 10 called numbers.
3. Press **OFF/CANCEL** to exit the redial list.

To redial a number:

When the desired number displays on the screen, press **DIAL** or the desired line key (**LINE 1-LINE 4**) to dial

Telephone operation

Options while on calls

Call waiting

If you subscribe to call waiting service with your telephone service provider, you hear a beep if someone calls while you are on a call.

- Press **FLASH** to put your current call on hold and take the new call.
- Press **FLASH** at any time to switch back and forth between calls.

Volume control

Use this feature to set the listening volume to one of six levels for the handset and speakerphone. While on a call, press **VOL▲** or **VOL▼** to adjust the listening volume.



NOTE: Handset and speakerphone volume settings are independent.

Mute

Use this feature during a telephone conversation to silence the microphone. You can hear the caller, but the caller cannot hear you.

To mute a call:

- Press **MUTE/DELETE**. When mute is on, the screen displays **MUTE**.

To take a call off mute:

- Press **MUTE/DELETE** again and resume speaking.

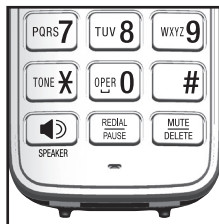

Telephone operation

Conference call

Conference calls

The handset can support 3-way conference with a maximum of one outside call and two system extensions (including the initiating party), or two outside calls and the handset itself. The outside call must be established first because an intercom call cannot be placed on hold.

There are two ways to establish a conference call.

A. Inviting parties using Intercom

The party who initiates the conference invites other system extensions to join the conference by using intercom after establishing the first outside call.

-OR-

B. Join a call by answering an intercom call

Other system extensions can join the call in progress by pressing the line key which is currently in use for the conference to join the call.

Telephone operation

Conference call

A. Inviting parties using Intercom

1. Make or answer an outside call.
2. Press another available line key to make another outside call. The original outside call is put on hold. When the external party picks up, you can have a private conversation with that party.

-OR-

Press **INT**. The outside call is put on hold. Press **▲** or **▼** to scroll to the desired extension, then press **MENU/SELECT** or **SELECT**. The called extension picks up the intercom call. You can now have a private conversation with that extension.

3. Press **MENU/SELECT**, then press **MENU/SELECT** again or **SELECT** to select **Conference** at any time to begin the conference call.
4. Press **OFF/CANCEL** to hang up. If the party who initiates the conference call hangs up, the call will be ended. The call will also be ended when all parties hang up.

B. Join a call in progress

1. If the call privacy of the registered UP416 console or UP406 deskset is set to **On**, turn the setting off before you proceed. Follow the instructions of **To turn call privacy off during a call** in the user's manual of UP416 or UP406.
2. Make or answer an outside call on the handset.
3. Any system extension can join the call by pressing the line key currently in use to join the conference until the maximum capacity is reached.
4. Press **OFF/CANCEL** to hang up. The call will be ended when all parties hang up.



NOTE: If the system extension who initiated the call does not turn off the call privacy setting and you try to join that call, the screen displays **Unavailable**.

Telephone operation

Intercom

You can use the intercom feature for conversations between the handset and a console or a deskset.

The console and each deskset in the telephone system **MUST** be assigned a unique extension number for the intercom feature to work. The assignment is done when the console or deskset is initially set up. The cordless handset shares the same extension as its registered console or deskset.

Make an intercom call to an extension

1. Press **INT** on the handset when it is idle.
2. Press **▲DIR** or **▼CID** to scroll to a desired extension, then press **MENU/SELECT** or **SELECT**.
3. The handset displays **Intercom to: XX** (**XX** represents the extension number of destination device).

Answer an intercom call

When you receive an intercom call, you hear a ringing tone and the handset displays **Intercom from: XX** (**XX** represents the extension number of the calling device). Press **INT** or **🔊/SPEAKER** to answer.

End an intercom call

Press **OFF/CANCEL** to hang up.

Answer an incoming call during an intercom call

If you receive an incoming outside call during an intercom call, there is an alert tone.

To answer the call, press the corresponding line key (**LINE 1-LINE 4**).

Directory

Create directory entries

Create a new directory entry

Use the following steps to store a name and number in the directory.

1. When the handset is idle, press **VOL/▲DIR**.
2. The handset displays **Directory XXX entries**. Press **ADD NEW** to add an entry.
3. The screen displays **Enter Name**. Use the dialing keys to enter the name (up to 15 characters).
 - Press **MUTE/DELETE** or **CLEAR** to delete a character.
 - Press **0** to add a space.
4. Press **MENU/SELECT** or **NEXT** to proceed. The screen displays **Enter Number**. Use the dialing keys to enter the number (up to 30 digits).
 - Press **MUTE/DELETE** or **CLEAR** to delete a digit.
5. Press **MENU/SELECT** or **NEXT** to save. The handset displays **Please Wait...**, and then you hear a confirmation tone. To exit without making changes, press **OFF/CANCEL**.



Review directory entries

1. When the handset is idle, press **▲DIR**.
2. The handset displays **Directory XXX entries**. Press **REVIEW**.
3. Press **▲DIR** or **▼CID** to browse through the directory. Entries appear alphabetically by the first letter in the name.
4. Press **OFF/CANCEL** to cancel an operation and return to idle mode.

Directory

Search directory

Search by name

Follow the steps below to search for directory entries on the handset.

1. When the handset is idle, press **vol/▲DIR**.
2. Press **REVIEW**, then press **▲DIR** or **▼CID** to browse through the directory.
3. When a name appears, press the dial pad keys (**2-9**) to start a name search. The directory shows the first name beginning with the first letter associated with the dial pad key, if there is an entry in the directory beginning with that letter. If there is no entry matching the letter you press, it remains in the current entry.
4. To see other names starting with the letters on the same dial pad key, keep pressing the key. The names appear in alphabetical order.

For example, if you have the names **Jennifer**, **Jessie**, **Kevin** and **Linda** in your directory:

- If you press **5 (JKL)** once, you see **Jennifer**.
- If you press **5 (JKL)** twice, you see **Kevin**.
- If you press **5 (JKL)** three times, you see **Linda**.
- To view **Jessie**, press **▼CID** while **Jennifer** is displayed.

Caller ID

Caller ID operation

Review the caller ID information

1. When the handset is idle, press **VOL/▼CID**.
2. The handset displays **Call History**
New Calls: XX and **Total Calls: XX**.
Press **REVIEW**.
3. Press **▲DIR** or **▼CID** to review the caller ID information. The caller ID history entries are stored in reverse chronological order, starting with the most recent entry.
4. To exit without making changes, press **OFF/CANCEL**.



Dial a call history entry

1. When in the caller ID history, press **▲DIR** or **▼CID** to browse the number you wish to call.
2. Press the desired line key (**LINE 1-LINE 4**).

Answering system

Private mailbox setup

Announcement

The system plays an outgoing announcement to the caller when the call is answered by the private mailbox. The system has a default announcement, *“Hello, please leave a message after the tone.”* You can use this announcement or record your own.

You can record an announcement up to 150 seconds.

To record the announcement:

1. When the handset is idle, press **ANS SYS**.
2. Press **▲DIR** or **▼CID** to scroll to **Private Mailbox**, then press **MENU/SELECT** or **SELECT**.
3. Press **MENU/SELECT** or **SELECT** to select **Announcement**.
4. Press **▲DIR** or **▼CID** to scroll to **Record**, then press **MENU/SELECT** or **SELECT**.
5. Speak towards the microphone and record your announcement. The screen displays **Record OGM** and the time elapsed. Press **MENU/SELECT** to stop recording.

Answering system

Answering system operation

Visual message waiting indicator

The handset displays **XX New message(s)** when there are new messages and/or memos in the central and private mailbox of its registered console, or in the private mailbox of its registered deskset.

Message playback

From the handset, you can play the messages in the private mailbox.

You can choose to listen to the new messages or all messages recorded in the private mailbox. All messages are played in chronological order.

When playback begins, the total number of messages is announced. Before each message, you hear the date and time of the recording. After the last message, you hear, “*End of the messages.*”

To listen to messages in the mailbox:

1. While the telephone is idle, press **ANS SYS** on the handset.
2. Press **MENU/SELECT** or **SELECT** to select **Play Messages**.
3. Press **▲DIR** or **▼CID** to choose **Play new msgs** to play the new message only or **Play all msgs** to play all the messages in the mailbox.
4. Press **MENU/SELECT** to play the messages.
5. The system announces the number of new or missed messages in the mailbox.

Options during playback

When a message is playing on the handset:

- Press **SKIP** to skip to the next message.
- Press **REPEAT** to repeat the current message. Immediately press **REPEAT** after the date and time announcement to hear the previous message.
- Press **5** to stop.

Appendix

Troubleshooting

If you have difficulty with your telephone, please try the suggestions below. For customer service, visit our website at **businessphones.vtech.com** or call **1 (800) 595-9511**. In Canada, dial **1 (800) 267-7377**

The handset registration is unsuccessful.

- Follow the handset registration instructions to register the handset again (see **To register a handset to your UP416 console** or **To register a handset to your UP406 deskset**).

My telephone doesn't work at all.

- Make sure the power cord is securely plugged in.
- Make sure you plug the battery connector securely into the cordless handset.
- Make sure you plug the telephone line cords securely and firmly into the console and the telephone wall jacks.
- Make sure you plug the Ethernet cable securely and firmly into the console and a router.
- Charge the battery in the cordless handset for at least 11 hours. For optimum daily performance, return the cordless handset to the charger when not in use.
- If the battery is depleted, charge the handset for at least 30 minutes before you use it.
- You may need to purchase a new battery. Refer to **Battery installation and charging** section.

Appendix

Troubleshooting

There is no dial tone.

- Try all the suggestions above.
- Move the cordless handset closer to the console or deskset. You may have moved out of range.
- If the previous suggestions do not work, disconnect the telephone line from the console and connect it to a different phone. If there is no dial tone on that phone either, the problem is in your wiring or telephone service. Contact your telephone service provider.
- Your line cord may be defective. Try installing a new line cord.

I cannot dial out.

- Try all the suggestions above.
- Make sure you have a dial tone before dialing. The cordless handset may take a second or two to find the console or deskset and produce a dial tone. This is normal. Wait an extra second before dialing.
- Eliminate any background noise. Noise from a television, radio or other appliances may cause the phone to not dial out properly. If you cannot eliminate the background noise, try muting the cordless handset before dialing, or dialing from another room with less background noise.
- If other phones in your home are having the same problem, contact your telephone service provider (charges may apply).

I cannot switch a call from the cordless handset to the console or deskset.

- Make sure the system has only one line operating. You cannot switch the call from the cordless handset to the console or deskset if there is more than one telephone line in operation.

Appendix

Maintenance

Taking care of your telephone

- Your cordless telephone contains sophisticated electronic parts, so you must treat it with care.
- Avoid rough treatment.
- Place the corded handset down gently.
- Save the original packing materials to protect your cordless telephone if you ever need to ship it.

Avoid water

- You can damage your cordless telephone if it gets wet. Do not use the corded handset in the rain, or handle it with wet hands. Do not install the cordless telephone near a sink, bathtub or shower.

Electrical storms

- Electrical storms can sometimes cause power surges harmful to electronic equipment. For your own safety, take caution when using electric appliances during storms.

Cleaning your telephone

- Your cordless telephone has a durable plastic casing that should retain its luster for many years. Clean it only with a soft cloth slightly dampened with water or a mild soap.
- Do not use excess water or cleaning solvents of any kind.

Remember that electrical appliances can cause serious injury if used when you are wet or standing in water. If the telephone base should fall into water, **DO NOT RETRIEVE IT UNTIL YOU UNPLUG THE POWER CORD AND TELEPHONE LINE CORDS FROM THE WALL**, then pull the unit out by the unplugged cords.

Appendix

FCC Part 68 and ACTA

This equipment complies with Part 68 of the FCC rules and with technical requirements adopted by the Administrative Council for Terminal Attachments (ACTA). The label on the back or bottom of this equipment contains, among other things, a product identifier in the format US:AAAEQ##TXXXX. This identifier must be provided to your telephone service provider upon request.

The plug and jack used to connect this equipment to premises wiring and the telephone network must comply with the applicable Part 68 rules and technical requirements adopted by ACTA. A compliant telephone cord and modular plug is provided with this product. It is designed to be connected to a compatible modular jack that is also compliant. An RJ11 jack should normally be used for connecting to a single line and an RJ14 jack for two lines. See Installation Instructions in the user's manual.

The Ringer Equivalence Number (REN) is used to determine how many devices you may connect to your telephone line and still have them ring when you are called. The REN for this product is encoded as the 6th and 7th characters following the US: in the product identifier (e.g., if ## is 03, the REN is 0.3). In most, but not all areas, the sum of all RENs should be five (5.0) or less. For more information, please contact your telephone service provider.

This equipment may not be used with Party Lines. If you have specially wired alarm dialing equipment connected to telephone line, ensure the connection of this equipment does not disable your alarm equipment. If you have questions about what will disable the alarm equipment, consult your telephone service provider or a qualified installer.

If this equipment is malfunctioning, it must be unplugged from the modular jack until the problem has been corrected. Repairs to this telephone equipment can only be made by the manufacturer or its authorized agents. For repair procedures, follow the instructions outlined under the Limited Warranty.

If this equipment is causing harm to the telephone network, the telephone service provider may temporarily discontinue your telephone service. The telephone service provider is required to notify you before interrupting service. If advance notice is not practical, you will be notified as soon as possible. You will be given the opportunity to correct the problem and the telephone service provider is required to inform you of your right to file a complaint with the FCC. Your telephone service provider may make changes in its facilities, equipment, operation, or procedures that could affect the proper functioning of this product. The telephone service provider is required to notify you if such changes are planned.

Appendix

FCC Part 68 and ACTA

If this product is equipped with a corded or cordless handset, it is hearing aid compatible.

If this product has memory dialing locations, you may choose to store emergency telephone numbers (e.g., police, fire, medical) in these locations. If you do store or test emergency numbers, please:

Remain on the line and briefly explain the reason for the call before hanging up.

Perform such activities in off-peak hours, such as early morning or late evening.

Industry Canada

This device complies with Industry Canada licence-exempt RSS standard(s).

Operation is subject to the following two conditions: (1) this device may not cause harmful interference, and (2) this device must accept any interference received, including interference that may cause undesired operation.

The term "IC:" before the certification/registration number only signifies that the Industry Canada technical specifications were met.

The Ringer Equivalence Number (REN) for this terminal equipment is 0.1. The REN is an indication of the maximum number of devices allowed to be connected to a telephone interface. The termination on an interface may consist of any combination of devices subject only to the requirement that the sum of the RENs of all the devices does not exceed five.

This product meets the applicable Industry Canada technical specifications.

This Class B digital apparatus complies with Canadian requirement:
CAN ICES-3 (B)/NMB-3(B).

Appendix

FCC Part 15

This equipment has been tested and found to comply with the requirements for a Class B digital device under Part 15 of the Federal Communications Commission (FCC) rules. These requirements are intended to provide reasonable protection against harmful interference in a residential installation. This equipment generates, uses and can radiate radio frequency energy and, if not installed and used in accordance with the instructions, may cause harmful interference to radio communications. However, there is no guarantee that interference will not occur in a particular installation. If this equipment does cause harmful interference to radio or television reception, which can be determined by turning the equipment off and on, the user is encouraged to try to correct the interference by one or more of the following measures:

- Reorient or relocate the receiving antenna.
- Increase the separation between the equipment and receiver.
- Connect the equipment into an outlet on a circuit different from that to which the receiver is connected.
- Consult the dealer or an experienced radio/TV technician for help.

Changes or modifications to this equipment not expressly approved by the party responsible for compliance could void the user's authority to operate the equipment.

This device complies with Part 15 of the FCC Rules. Operation is subject to the following two conditions: (1) this device may not cause harmful interference, and (2) this device must accept any interference received, including interference that may cause undesired operation. Privacy of communications may not be ensured when using this telephone.

To ensure safety of users, the FCC has established criteria for the amount of radio frequency energy that can be safely absorbed by a user or bystander according to the intended usage of the product. This product has been tested and found to comply with the FCC criteria. The handset may be safely held against the ear of the user. The telephone base shall be installed and used such that parts of the user's body other than the hands are maintained at a distance of approximately 20 cm (8 inches) or more. If you choose to use a clipping device, please make sure to only use the supplied VTech belt clip.

For body worn operation, this handset has been tested and meets the FCC RF exposure guidelines when used with the belt clip supplied or designated for this product. Use of other accessories may not ensure compliance with FCC RF exposure guidelines.

Appendix

Limited warranty

1. What does this limited warranty cover?

The manufacturer of this VTech product warrants to the holder of a valid proof of purchase (“CONSUMER” or “you”) that the product and all accessories provided in the sales package (“PRODUCT”) are free from defects in material and workmanship, pursuant to the following terms and conditions, when installed and used normally and in accordance with the PRODUCT operating instructions. This limited warranty extends only to the CONSUMER for products purchased and used in the United States of America and Canada.

2. What will be done if the PRODUCT is not free from defects in materials and workmanship during the limited warranty period (“materially defective PRODUCT”)?

During the limited warranty period, VTech’s authorized service representative will repair or replace at VTech’s option, without charge, a materially defective PRODUCT. If we repair the PRODUCT, we may use new or refurbished replacement parts. If we choose to replace the PRODUCT, we may replace it with a new or refurbished PRODUCT of the same or similar design. We will retain defective parts, modules, or equipment. Repair or replacement of the PRODUCT, at VTech’s option, is your exclusive remedy. VTech will return repaired or replacement products to you in working condition. You should expect the repair or replacement to take approximately 30 days.

3. How long is the limited warranty period?

The limited warranty period for the PRODUCT extends for TWO (2) YEARS from the date of purchase. If VTech repairs or replaces a materially defective PRODUCT under the terms of this limited warranty, this limited warranty also applies to repaired or replacement PRODUCT for a period of either (a) 90 days from the date the repaired or replacement PRODUCT is shipped to you or (b) the time remaining on the original two-year limited warranty; whichever is longer.

Appendix

Limited warranty

4. What is not covered by this limited warranty?

This limited warranty does not cover:

- PRODUCT that has been subjected to misuse, accident, shipping or other physical damage, improper installation, abnormal operation or handling, neglect, inundation, fire, water, or other liquid intrusion; or
- PRODUCT that has been damaged due to repair, alteration, or modification by anyone other than an authorized service representative of VTech; or
- PRODUCT to the extent that the problem experienced is caused by signal conditions, network reliability or cable or antenna systems; or
- PRODUCT to the extent that the problem is caused by use with non-VTech accessories; or
- PRODUCT whose warranty/quality stickers, PRODUCT serial number plates or electronic serial numbers have been removed, altered or rendered illegible; or
- PRODUCT purchased, used, serviced, or shipped for repair from outside the United States of America or Canada, or used for commercial or institutional purposes (including but not limited to products used for rental purposes); or
- PRODUCT returned without a valid proof of purchase (see item 6 below); or
- Charges for installation or setup, adjustment of customer controls, and installation or repair of systems outside the unit.

5. How do you get warranty service?

To obtain warranty service, visit **businessphones.vtech.com** or call **1 (800) 595-9511**. In Canada, please dial **1 (800) 267-7377**.

NOTE: Before calling for service, please review the user's manual; a check of the PRODUCT's controls and features may save you a service call.

Except as provided by applicable law, you assume the risk of loss or damage during transit and transportation and are responsible for delivery or handling charges incurred in the transport of the PRODUCT(s) to the service location. VTech will return repaired or replaced PRODUCT under this limited warranty to you. Transportation, delivery or handling charges are prepaid. VTech assumes no risk for damage or loss of the PRODUCT in transit. If the PRODUCT failure is not covered by this limited warranty, or proof of purchase does not meet the terms of this limited warranty, VTech will notify you and will request that you authorize the cost of repair prior to any further repair activity. You must pay for the cost of repair and return shipping costs for the repair of products that are not covered by this limited warranty.

Appendix

Limited warranty

6. What must you return with the PRODUCT to get warranty service?

You must:

- Return the entire original package and contents including the PRODUCT to the service location along with a description of the malfunction or difficulty; and
- Include a “valid proof of purchase” (sales receipt) identifying the PRODUCT purchased (PRODUCT model) and the date of purchase or receipt; and
- Provide your name, complete and correct mailing address, and telephone number.

7. Other limitations

This warranty is the complete and exclusive agreement between you and VTech. It supersedes all other written or oral communications related to this PRODUCT. VTech provides no other warranties for this PRODUCT. The warranty exclusively describes all of VTech’s responsibilities regarding the PRODUCT. There are no other express warranties. No one is authorized to make modifications to this limited warranty and you should not rely on any such modification.

State/Provincial Law rights: This warranty gives you specific legal rights, and you may also have other rights which vary from state to state or province to province.

Limitations: Implied warranties, including those of fitness for a particular purpose and merchantability (an unwritten warranty that the PRODUCT is fit for ordinary use) are limited to one year from date of purchase. Some states/provinces do not allow limitations on how long an implied warranty lasts, so the above limitation may not apply to you. In no event shall VTech be liable for any indirect, special, incidental, consequential, or similar damages (including, but not limited to lost profits or revenue, inability to use the PRODUCT or other associated equipment, the cost of substitute equipment, and claims by third parties) resulting from the use of this PRODUCT. Some states/provinces do not allow the exclusion or limitation of incidental or consequential damages, so the above limitation or exclusion may not apply to you.

Please retain your original sales receipt as proof of purchase.

Appendix

Technical specifications

RF frequency band	1921.536MHz - 1928.448MHz
Channels	5
Operating temperature	32°F - 122°F 0°C - 50°C
Handset voltage	2.4V 550mAh Ni-MH battery
Charger voltage (AC adapter output)	6VAC @300mA

Operation	Operating time*
Talk time (cordless handset)	Up to seven hours
Talk time (cordless handset speakerphone)	Up to five hours
Standby	Up to seven days

* Operating times vary depending on your actual use and the age of the battery.

DECT 6.0 digital technology

Digital Enhanced Cordless Telecommunications (DECT) 6.0 is a new frequency band that transmits your voice across multiple channels. This technology provides superior quality of voice and sound, high protection against wiretapping and excellent range, while not interfering with wireless routers.

Telephone operating range

This cordless telephone operates within the maximum power allowed by the Federal Communications Commission (FCC). Even so, this handset and telephone base can communicate over only a certain distance — which can vary with the locations of the telephone base and handset, the weather, and the construction of your home or office.



Designed to fit your home.
And your life.

VTech Communications, Inc.

A member of THE VTECH GROUP OF COMPANIES.

VTech is a registered trademark of VTech Holdings Limited.

Specifications are subject to change without notice.

© 2014 VTech Communications, Inc.

All rights reserved. 04/14. UP407_ACIB_V1.0

Document order number: 91-007445-010-100